



Installation & Maintenance Manual

4 channel Flow Monitor

For Air
Series PF2A 200 / PF2A 201
For Water
Series PF2W 200 / PF2W 201
For Pure Water/Chemical Fluid
Series PF2D 200 / PF2D 201



EMC Directives
 EN61000-6-2:2001 Electromagnetic Compatibility (EMC). Generic standards - Immunity for industrial environments.
 EN55011+ A1+A2:2001 Limits and methods of measurement of radio disturbance characteristics of industrial, scientific and medical radio-frequency equipment and light industrial environments.

Safety Instructions

The Digital Flow Monitor and this manual contain essential information for the protection of users and others from possible injury and property damage and to ensure correct handling. Please confirm that you fully understand the definition of the following messages (signs) before going on to read the text, and always follow the instructions. Please read and understand the operation manuals of related apparatus before operating the flow switch.

IMPORTANT MESSAGES	
Read this manual and follow its instructions. Signal words such as WARNING and NOTE will be followed by important safety information that must be carefully reviewed.	
WARNING	Indicates a potentially hazardous situation that could result in death or serious injury if you do not follow instructions.
NOTE	Gives you helpful information.

WARNING	
Do not disassemble, modify (including change of printed circuit board) or repair. An injury or failure can result.	
Do not operate outside of the specification. Fire, malfunction or flow monitor damage can result. Please use it after confirming the specification.	
Do not operate in an environment of inflammable, explosive or corrosive gas. Fire or an explosion can result. This flow monitor is not an explosion proof type.	
Prepare a double interlock using another system (Mechanical interlock, etc.), and check it is operating correctly, when using this product in an interlock circuit. An accident by a malfunction may potentially result.	

SAFETY (continue)

NOTE

- Follow the instructions given below when handling the flow monitor. Otherwise, the flow monitor may be damaged or may fail, thereby resulting in malfunction.
- Do not drop, bring into collision with other objects or apply excessive shock to the unit (980m/s² or more).
 - Do not pull the lead wire with force or lift the flow monitor by holding the lead wire. Pulling strength is as follows.
Power and output lead wire : less than 50N
Lead wire with connector for sensor : less than 25N
 - Do not use in a place in which oil or chemical splashes may occur.
 - Connect wires and cables correctly.
 - Do not perform wiring while power is on.
 - Although the flow monitor complies with the CE Marking, it does not have lightning surge protection, therefore please apply the necessary protection to the equipment.
 - Although the flow monitor complies with the CE Marking, it should be protected against any sources of surge (electro-magnetic lifter, high frequency induction furnace, motors etc.) around the flow monitor.
 - Do not use with power cable or high-voltage cable in the same wire route.
 - Connect Terminal FG to ground when using a switching regulator obtained on the commercial market.
 - Turn on the power supply of a flow monitor for Air, when the flow is zero. Some initial drift occurs during ten minutes after turning the power on.
 - Do not insert or remove flow sensor (connector) with the power ON.
 - Do not press the setting buttons with a sharp pointed object.
 - For 3 seconds after power is turned ON the measurement output will be OFF. This includes after momentary disconnection of the power, by reset etc.)
 - During initial setting or when setting the flow monitor, the measured output continues to change with the flow measurement as before setting. Please check how this will affect the equipment before use. Check the flow monitor set up after a control system is shut down, if required.

Model Indication Method

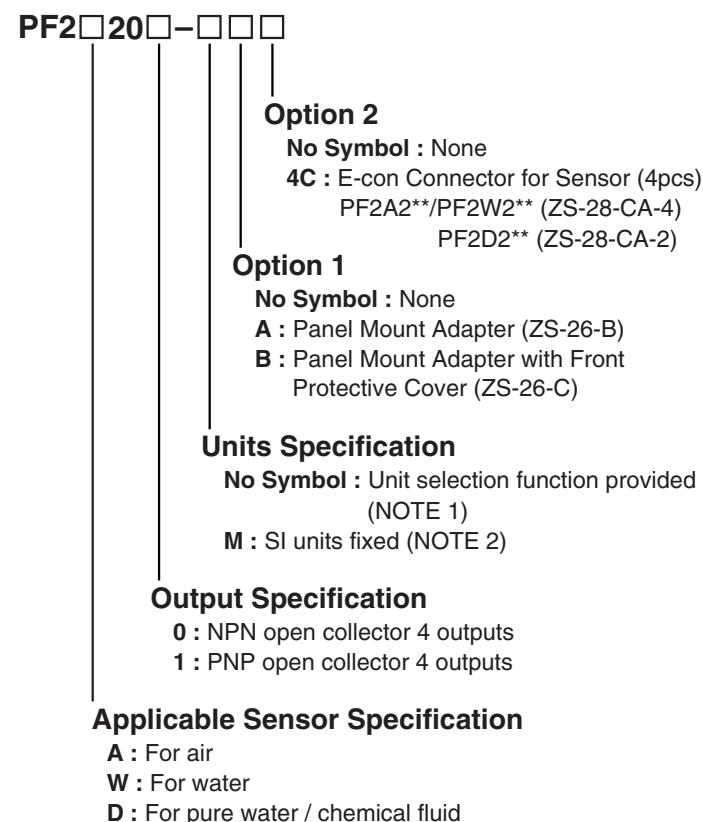

NOTE 1 : The new Measurement Law prohibits use in Japan of the Flow Monitor with a unit selection function.
 NOTE 2 : Fixed unit for instantaneous flow rate is : ℓ/min
 for integrated flow rate is : ℓ

Specification

• For Air

		PF2A200/201				
Applicable flow sensor		PF2A510-□-1	PF2A550-□-1	PF2A511-□-1	PF2A521-□-1	PF2A551-□-1
Flow rate indication range *1		0.5 to 10.5 ℓ/min	2.5 to 52.5 ℓ/min	5 to 105 ℓ/min	10 to 210 ℓ/min	25 to 525 ℓ/min
Set flow rate range *1		0.5 to 10.5 ℓ/min	2.5 to 52.5 ℓ/min	5 to 105 ℓ/min	10 to 210 ℓ/min	25 to 525 ℓ/min
Minimum set unit *1		0.1 ℓ/min	0.5 ℓ/min	1 ℓ/min	2 ℓ/min	5 ℓ/min
Flow rate conversion value (Pulse width:50ms) *1		0.1 ℓ/pulse	0.5ℓ/pulse	1ℓ/pulse	2ℓ/pulse	5ℓ/pulse
Unit *1,2	Instantaneous flow rate	ℓ/min, CFM × 10 ⁻²		ℓ/min, CFM × 10 ⁻¹		
	Integrated flow rate	ℓ, ft ³ × 10 ⁻²		ℓ, ft ³ × 10 ⁻¹		
Integrated flow rate range *1		0 to 999999 ℓ, 0 to 999999ft ³ × 10 ⁻²		0 to 999999 ℓ, 0 to 999999ft ³ × 10 ⁻¹		
Power supply voltage		24VDC, ripple (p-p) ±10% or less (Protected against inverse connection)				
Current consumption		55mA or less (Except for consumed current of sensor part)				
Power supply voltage for sensor		Same as Power supply voltage				
Power supply current for sensor *3		Max. 110mA (Max. total consumed current is 440mA or less for inputting 4 sensors.)				
Sensor input		1 to 5VDC (Input impedance : Approx. 800k)				
	Number of input	4 inputs				
	Input protection	With over voltage protection				
Output specification *4	Switch Output or Integrated Pulse Output	NPN open collector (PF2A200)	Maximum load current : 80mA Internal voltage drop : 1V or less (@load current 80mA) Maximum input voltage : 30V			
		PNP open collector (PF2A201)	Maximum load current : 80mA Internal voltage drop : 1V or less (@load current 80mA)			
Number of output		4 outputs (1 output per each sensor input)				
Output protection		Short circuit protection is provided				

		PF2A200/201
Hysteresis		Hysteresis Mode: Variable (Settable starting 0), Window Comparator Mode: fixed (3digits)
Response time *5		1s or less
Linearity *5		±5% F.S. or less
Repeatability *5		±3% F.S. or less
Temperature characteristic		±2% F.S. or less (0 to 50°C, 25°C)
LCD display		Display for measured value : 4 digits 7-segment(Orange) Display for channel : 1 digit 7-segment (Red)
Operation display		Illuminates when output is ON (Red)
Environment	Enclosure	Front part : IP65 (Panel mounted), Others : IP40
	Operating temp. range	Operation: 0 to 50°C, Storage : -10 to 60°C (No condensation, no freezing)
	Operating humidity range	Operation/Storage : 35 to 85% RH (No condensation)
	Vibration proof	10 to 500Hz smaller one 1.5mm or 98m/s ² double amplitude, each in directions of X, Y and Z for 2 hours
	Impact proof	980m/s ² , 3 times each in directions of X, Y and Z respectively
Resistance to noise		500Vp-p pulse width 1μs, rise 1ns
Connection		Power supply and output connection : 8P connector, Sensor connection : 4P e-con
Material		Body : PBT, Display : PET, Rear Rubber cover : CR
Mass (Weight)		60g (Accessories not included)

*1 Without units selection function, fixed to SI units (ℓ/min or ℓ).
 *2 Two units in normal condition (0°C/101.3kPa) or standard condition (ANR : 20°C/101.3kPa/65%RH) can be selected.
 *3 Over current on Vcc side and 0V side of sensor input connector results in breakage of internal parts of this Flow Monitor.
 *4 Select either switch output or pulse output of integrated flow rate at initialization.
 *5 This is system accuracy when combined with a compatible flow sensor.
 *6 This product conforms to the CE standard.

• For Water

		PF2W200/201			
Applicable flow sensor		PF2W504-□-1	PF2W520-□-1	PF2W540-□-1	PF2W511-□-1
Flow rate indication range *1		0.35 to 4.50 ℓ/min	1.7 to 17.0 ℓ/min	3.5 to 45.0 ℓ/min	7 to 110 ℓ/min
Set flow rate range *1		0.35 to 4.50 ℓ/min	1.7 to 17.0 ℓ/min	3.5 to 45.0 ℓ/min	7 to 110 ℓ/min
Minimum set unit *1		0.05 ℓ/min	0.1 ℓ/min	0.5 ℓ/min	1 ℓ/min
Flow rate conversion value (Pulse width:50ms) *1		0.05ℓ /pulse	0.1 ℓ/pulse	0.5 ℓ/pulse	1 ℓ/pulse
Unit *1	Instantaneous flow rate	ℓ/min, gal(US) /min			
	Integrated flow rate	ℓ, gal(US) /min			
Integrated flow rate range *1		0 to 999999 ℓ, 0 to 999999 gal(US)			
Power supply voltage		24VDC, ripple (p-p) ±10% or less (Protected against inverse connection)			
Current consumption		55mA or less (Except for consumed current of sensor part)			
Power supply voltage for sensor		Same as Power supply voltage			
Power supply current for sensor *2		Max. 110mA (Max. total consumed current is 440mA or less for inputting 4 sensors.)			
Sensor input		1 to 5VDC (Input impedance : Approx. 800k)			
	Number of input	4 inputs			
	Input protection	With over voltage protection			
Output specification *3	Switch Output or Integrated Pulse Output	NPN open collector (PF2W200)	Maximum load current : 80mA Internal voltage drop : 1V or less (@load current 80mA) Maximum input voltage : 30V		
		PNP open collector (PF2W201)	Maximum load current : 80mA Internal voltage drop : 1V or less (@load current 80mA)		
Number of output		4 outputs (1 output per each sensor input)			
Output protection		Short circuit protection is provided			

		PF2W200/201
Hysteresis		Hysteresis Mode: Variable (Settable starting 0), Window Comparator Mode: fixed (3digits)
Response time *4		1s or less
Linearity *4		±5% F.S. or less
Repeatability *4		±3% F.S. or less
Temperature characteristic		±2% F.S. or less (0 to 50°C, 25°C)
LCD display		Display for measured value : 4 digits 7-segment(Orange) Display for channel : 1 digit 7-segment (Red)
Operation display		Illuminates when output is ON (Red)
Environment	Enclosure	Front part : IP65 (Panel mounted), Others : IP40
	Operating temp. range	Operation: 0 to 50°C, Storage : -10 to 60°C (No condensation, no freezing)
	Operating humidity range	Operation/Storage : 35 to 85% RH (No condensation)
	Vibration proof	10 to 500Hz smaller one 1.5mm or 98m/s ² double amplitude, each in directions of X, Y and Z for 2 hours
	Impact proof	980m/s ² , 3 times each in directions of X, Y and Z respectively
Resistance to noise		500Vp-p pulse width 1μs, rise 1ns
Connection		Power supply and output connection : 8P connector, Sensor connection : 4P e-con
Material		Body : PBT, Display : PET, Rear Rubber cover : CR
Mass (Weight)		60g (Accessories not included)

*1 Without units selection function, fixed to SI units (ℓ/min or ℓ).
 *2 Over current on Vcc side and 0V side of sensor input connector results in breakage of internal parts of this Flow Monitor..
 *3 Select either switch output or pulse output of integrated flow rate at initialization.
 *4 This is system accuracy when combined with a compatible flow sensor.
 *5 This product conforms to the CE standard.

Specification (continue)

• For Pure Water/Chemical Fluid

		PF2D200/201		
Applicable flow sensor		PF2D504-□-1	PF2D520-□-1	PF2D540-□-1
Flow rate indication range *1		0.25 to 4.50 ℓ/min	1.3 to 21.0 ℓ/min	2.5 to 45.0 ℓ/min
Set flow rate range *1		0.25 to 4.50 ℓ/min	1.3 to 21.0 ℓ/min	2.5 to 45.0 ℓ/min
Minimum set unit *1		0.05 ℓ/min	0.1 ℓ/min	0.5 ℓ/min
Flow rate conversion value (Pulse width:50ms) *1		0.05 ℓ/pulse	0.1 ℓ/pulse	0.5 ℓ/pulse
Unit *1	Instantaneous flow rate	ℓ/min, gal(US) /min		
	Integrated flow rate	ℓ, gal(US)		
Integrated flow rate range *1		0 to 999999 ℓ, 0 to 999999 gal(US)		
Power supply voltage		24VDC, ripple (p-p) ±10% or less (Protected against inverse connection)		
Current consumption		55mA or less (Except for consumed current of sensor part)		
Power supply voltage for sensor		Same as Power supply voltage		
Power supply current for sensor *2		Max. 110mA (Max. total consumed current is 440mA or less for inputting 4 sensors.)		
Sensor input		1 to 5VDC (Input impedance : Approx. 800k)		
	Number of input	4 inputs		
	Input protection	With over voltage protection		
Output specification *3	Switch Output or Integrated Pulse Output	NPN open collector (PF2D200)	Maximum load current : 80mA Internal voltage drop : 1V or less (@load current 80mA) Maximum input voltage : 30V	
		PNP open collector (PF2D201)	Maximum load current : 80mA Internal voltage drop : 1V or less (@load current 80mA)	
	Number of output	4 outputs (1 output per each sensor input)		
Output protection		Short circuit protection is provided		

		PF2D200/201
Hysteresis		Hysteresis Mode: Variable (Settable starting 0), Window Comparator Mode: fixed (3digits)
Response time *4		1s or less
Linearity *4		±5% F.S. or less
Repeatability *4		±3% F.S. or less
Temperature characteristic		±2% F.S. or less (0 to 50°C, 25°C)
LCD display		Display for measured value : 4 digits 7-segment (Orange) Display for channel : 1 digit 7-segment (Red)
Operation display		Illuminates when output is ON (Red)
Environment	Enclosure	Front part : IP65 (Panel mounted), Others : IP40
	Operating temp. range	Operation: 0 to 50°C, Storage : -10 to 60°C (No condensation, no freezing)
	Operating humidity range	Operation/Storage : 35 to 85% RH (No condensation)
	Vibration proof	10 to 500Hz smaller one 1.5mm or 98m/s ² double amplitude, each in directions of X, Y and Z for 2 hours
	Impact proof	980m/s ² , 3 times each in directions of X, Y and Z respectively
Resistance to noise		500Vp-p pulse width 1μs, rise 1ns
Connection		Power supply and output connection : 8P connector, Sensor connection : 4P e-con
Material		Body : PBT, Display : PET, Rear Rubber cover : CR
Mass (Weight)		60g (Accessories not included)

*1 Without units selection function, fixed to SI units (ℓ/min or ℓ).
 *2 Over current on Vcc side and OV side of sensor input connector results in breakage of internal parts of this Flow Monitor.
 *3 Select either switch output or pulse output of integrated flow rate at initialization.
 *4 This is system accuracy when combined with a compatible flow sensor.
 *5 This product conforms to the CE standard.

Outline with Dimensions (in mm)

Dimensions of Main Unit

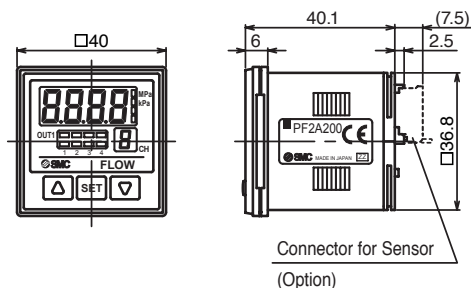

Front Face protective Cover + Panel Mount Type

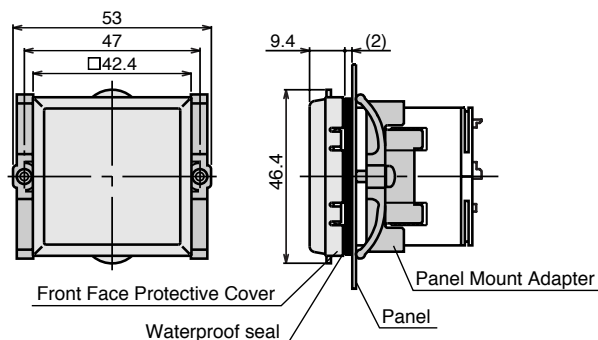

Name and Functions of Individual Parts

Main Unit

Switch Output Lamp : Lit when OUT1 (CH1 to CH4) is ON.
 Flow Rate Unit Display for Air : Lit when (nor) normal condition (CH1 to CH4) is selected (Only for PF2A20* for Air).
 LCD Display : Displays the current status of flow, setting mode, (Orange) selected indication unit and error codes.
 [△] Button : Selects the mode and increases a set ON/OFF value.
 [▽] Button : Selects the mode and decreases a set ON/OFF value.
 [SET] Button : Changes the mode and sets a set value.
 Unit Display : Lit ON to indicate the selected unit. For the Flow (Orange) Monitor without unit selection function, the unit is fixed to SI (ℓ/min or ℓ).
 Unit label : Attach the unit label (CFM, ft³, gal(US)/min, gal(US)) with a unit selection function.
 Channel Indicator : Indicates the channel (1 to 4) that is selected (Red).

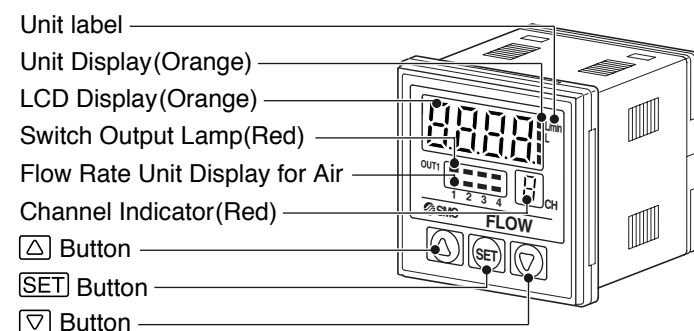

Name and Functions of Individual Parts (continue)

Accessories

Power and Output Lead Wire with Connector (2m) : **ZS-26-A**

Options

Connector (e-con) for Sensor Lead Wire (1pc) : PF2A2****ZS-28-CA-4**
 PF2W2****ZS-28-CA-4**
 PF2D2****ZS-28-CA-2**

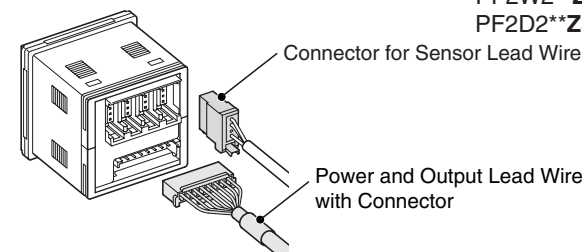

Panel Mount Adapter with set screws M3×8L (2pcs) : **ZS-26-B** and waterproof seal

Panel Mount Adapter + Front Face Protective Cover : **ZS-26-C** with set screws M3×8L (2pcs) and waterproof seal

Front Face Protective Cover : **ZS-26-01**

Installation

Mounting with Panel mount adapter

•Fix the panel mount adapter to the Flow Monitor with the set screws M3×8L (2pcs) as attached.

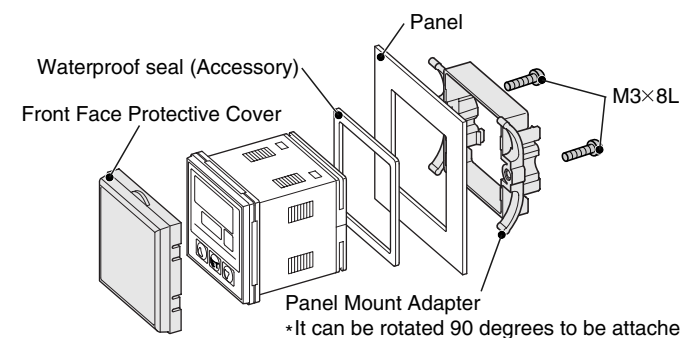

*It can be rotated 90 degrees to be attached.
 *Panel mounting of the flow monitor meets IP65. However, liquid may infiltrate if the panel mount adapter is not installed securely or the instrument is not seated correctly. Tighten the screws by 1/4 to 1/2 turn more after the heads make contact with the panel.

Panel Cut Dimensions

Panel thickness: 0.5 to 8mm

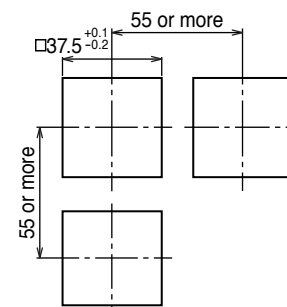

Installation (continue)

Connection

- Turn off the power before connecting or disconnecting the connectors.
- Install the lead wire separately from the route for power cable or high-voltage cable. Otherwise, malfunction may potentially result due to noise.
- Be sure to ground Terminal FG when using a switching regulator obtained on the commercial market.

Notice when removing the panel mount adapter

- The Flow Monitor with panel mount adapter can be removed from panel after removing two screws as shown in the figure, by inserting a suitable thin card both sides to disconnect the hooks. Pull the panel mount adapter to the front, and remove the flow monitor. If panel mount adapter is drawn forward with hook caught, the adapter and the Flow Monitor may be damaged.

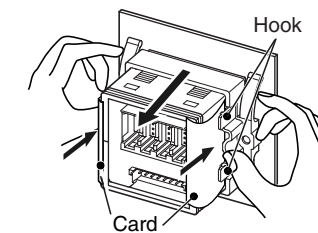

Attaching connector to sensor lead wire

- Strip the sensor wire as shown in the right figure. Connector cover 20mm or more
- The core of the corresponding color shown in the following table is put into the pin of the number printed on the e-con connector, and pushed to the back.

Pin No.	Color of Insulation
1	Brown (DC (+))
2	N.C.
3	Blue (DC (-))
4	Black (IN:1 to 5VDC)

- Check that the above-mentioned preparation work has been performed correctly, then part A shown in the figure is pushed in by hand to make temporary connection.
- Part A center is pressed straight in using a tool, such as pliers.
- Re-use cannot be performed once the e-con connector has been completely crimped.
- In case connection failure such as incorrect order of wires or incomplete insertion, please use a new e-con connector.

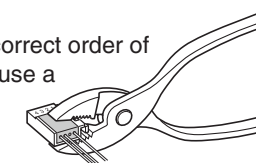

Internal Circuit and Wiring

Connector Connecting/Disconnecting

- When connecting the connector, insert it straight onto the pins and lock the connector into the square groove in the housing until connector clicks.
- When disconnecting the connector, press the connector lever to disengage the lever claw from the square groove. Then pull out the connector straight.

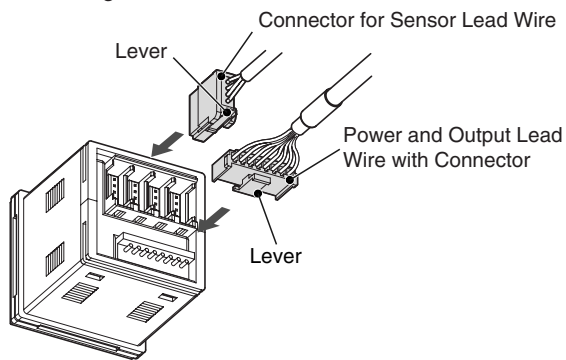

Power and Output Connector Pin numbers

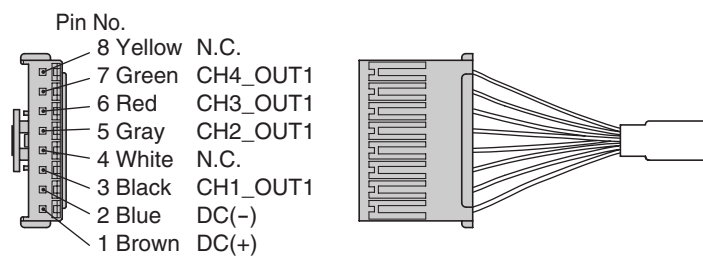

Output Specification

When the SMC Power and Output Lead Wire (type ZS-26-A) is used, the colors of wire (Brown, Blue, Black, White, Grey, Red, Green, Yellow) will apply as shown on circuit diagram.

PF2□200 : NPN Open Collector 4 outputs
Max. 30V, 80mA Residual voltage 1V or less

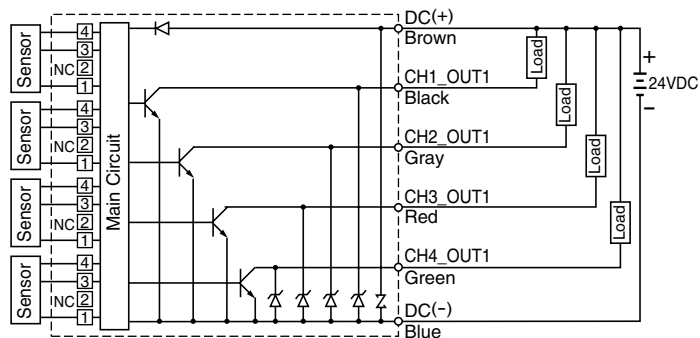

PF2□201 : PNP Open Collector 4 outputs
Max. 80mA Residual voltage 1V or less

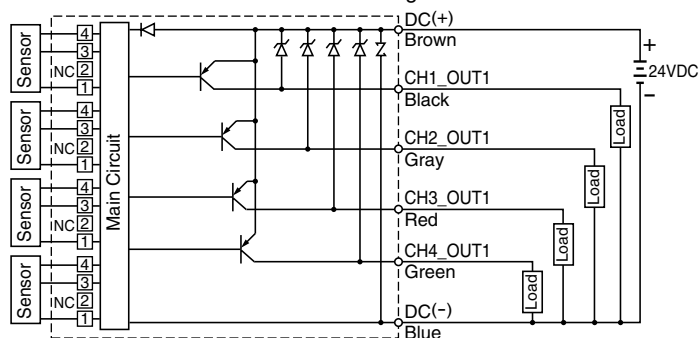

Setting

Setting Procedures

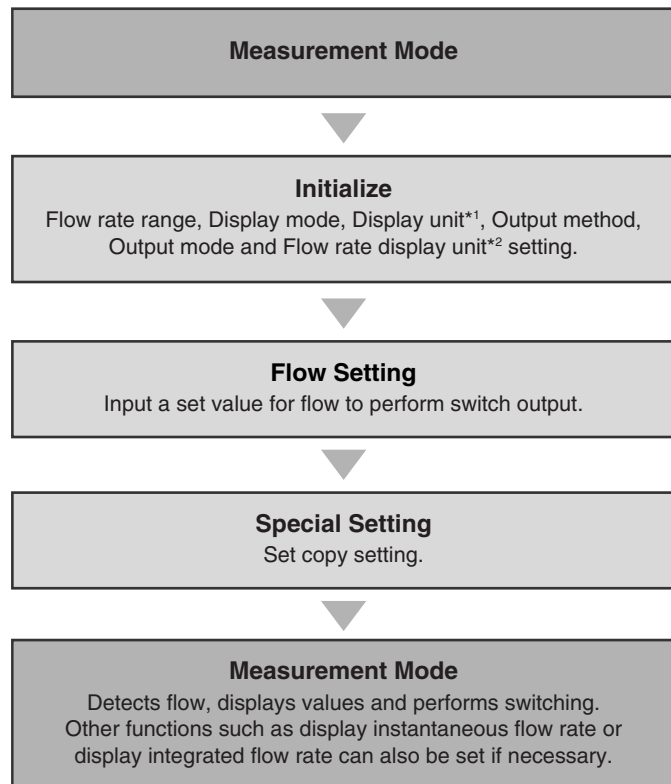

*1 When [-M] is not assigned to units specification in model indication.

*2 Only for PF2A20□ for Air.

Initialize

Select the setting channel by pressing the Δ button, then press and hold the SET button longer than 2 seconds. When indication on display changes from [F_1], [F_2] or [F_3] to one of the following, press SET button (refer to table below).

1. Flow Rate Range Setting

Select the flow rate range suitable for the flow sensor connected. Press the Δ button and select the flow rate range for the sensor part to connect, and press the SET button to set.



Display part	LED Display	Sensor part (Flow rate range)
PF2A 20□	10L	PF2A 510-□-1 (1 to 10 ℓ/min)
	50L	PF2A 550-□-1 (5 to 50 ℓ/min)
	11L	PF2A 511-□-1 (10 to 100 ℓ/min)
	21L	PF2A 521-□-1 (20 to 200 ℓ/min)
	51L	PF2A 551-□-1 (50 to 500 ℓ/min)
PF2D20□	04d	PF2D 504-□-1 (0.4 to 4 ℓ/min)
	20d	PF2D 520-□-1 (1.8 to 20 ℓ/min)
	40d	PF2D 540-□-1 (4 to 40 ℓ/min)
PF2W20□	04L	PF2W 504-□-1 (0.5 to 4 ℓ/min) PF2W 504T-□-1 (0.5 to 4 ℓ/min)
	20L	PF2W 520-□-1 (2 to 16 ℓ/min) PF2W 520T-□-1 (2 to 16 ℓ/min)
	40L	PF2W 540-□-1 (5 to 40 ℓ/min) PF2W 540T-□-1 (5 to 40 ℓ/min)
	11L	PF2W 511-□-1 (10 to 100 ℓ/min)

Initialize (continue)

2. Display Mode Setting

Select whether to display instantaneous flow rate or integrated flow rate.



To change the Display mode, press the Δ button and select the desired flow rate to display. Then press the SET button. [d_1] indicates display of instantaneous flow rate and [d_2] indicates integrated flow rate.

3. Selecting Display Unit

When [-M] is not assigned to units specification in model indication

Two units each in instantaneous flow rate or integrated flow rate can be selected. Pressing the Δ button in unit setting mode will change the units and a set value will be converted automatically.

Press the SET button to set and to move to setting the output method.

Display part	LED display	Instantaneous flow rate	Integrated flow rate
PF2A 20□	U_1	ℓ/min	ℓ
	U_2	CFM×10 ² , CFM×10 ¹ ••*1	ft ³ ×10 ² , ft ³ ×10 ¹ ••*1
PF2D20□	U_1	ℓ/min	ℓ
	U_2	gal(US)/min	gal(US)
PF2W20□	U_1	ℓ/min	ℓ
	U_2	gal(US)/min	gal(US)

*1. CFM×10², ft³×10² for PF2A5□0-□-1 and CFM×10¹, ft³×10¹ for PF2A5□1-□-1 is selected respectively.

4. Output Method Setting

Three output methods are available, namely, instantaneous switch, integrated switch and integrated pulse. The method for output to OUT1 is set as follows.



•Press the Δ button and select the instantaneous switch, integrated switch or integrated pulse.

[o10] indicates the instantaneous switch, [o11] integrated switch and [o12] integrated pulse.

•The setting is fixed by pressing SET button, and the display will move to output mode setting.

5. Output Mode Setting

Two output modes are available, namely, the Reverse Output mode and Non-Reverse Output mode. An output mode for OUT1 is set.

•Press the Δ button and select the Reverse Output mode or Non-Reverse Output mode.

[1_n] and [1_P] respectively indicate the Reverse Output mode and Non-Reverse Output mode.



•The setting is fixed by pressing SET button.

For PF2A20* display will move to flow rate display unit selection. For PF2D20* and PF2W20* display will return to measurement mode.

6. Selecting Flow Rate Display Unit (Only for PF2A 20□ for Air)

Either normal condition or standard condition (ANR) can be selected.

Normal condition: 0°C/ 101.3kPa

Standard condition: 20°C/ 101.3kPa/ 65%RH

•Press the Δ button and select the display unit. [nor] indicates normal condition and [Anr] indicates Standard condition.



•When normal condition is selected, the flow rate unit display for air LED will light up.

•The setting is fixed by pressing SET button, and the display will return to measurement mode.



Display Function of Integrated Flow Rate Value

•If integrated flow rate display is selected at initial setting, the following operation can start, stop and clear the integration. To start integration, first Δ button and SET button are pressed simultaneously and held until [-] begins flashing.

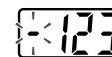

•Lower three digits of an integrated value are always displayed. To check upper 3 digits, first Δ button and then Δ button are pressed and held.

•Pressing the Δ button enables to display the instantaneous flow rate even during integration.

•To stop integration, press the Δ button first, then the SET button, to press both buttons simultaneously.

The display will keep the present integrated value. To further continue integration from the saved value, repress the Δ button first, then the SET button, to press both buttons simultaneously.

•To clear integration, stop integration at first, and press both Δ button and SET button and hold for 4 seconds or more.

Instantaneous Flow Rate Setting Mode

Manually set the required actuation value when the instantaneous value switch has been selected in initialization.

The output method is also set in accordance with the set value.

Set the output method while referring to the output method described later in this manual.

1. Press and hold the SET button and release when [F_1] is displayed.

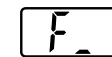

2. Press the SET button to input a set value in [n_1] ([P_1] in the Non-Reverse Output mode) for OUT1.

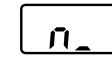

When the Reverse Output mode is selected in initialization, [n_1] and the set value will be displayed alternately. (When the Non-Reverse Output mode is selected in initialization, [P_1] and the set value will be displayed alternately.)

3. Press the Δ button or Δ button to select a desired set value. Press the Δ button to increase the set value or the Δ button to decrease the set value.

4. Press the SET button to set the value and to move to the setting mode for [n_2] ([P_2] in the Non-Reverse Output mode).

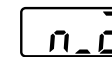

When the Reverse Output mode is selected in initialization, [n_2] and the set value will be displayed alternately.

(When the Non-Reverse Output mode is selected in initialization, [P_2] and the set value will be displayed alternately.)

5. Press the Δ button or Δ button to select a desired set value. Press the Δ button to increase the set value or the Δ button to decrease the set value.

6. Press the SET button to set the value and the display will return to measurement mode.

Integrated Flow Rate Setting Mode

Set the required actuation value when the integrated value switch has been selected in initialization. The output method is also set manually in accordance with the set value. Set the output method while referring to the output method described later in this manual.

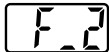
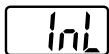
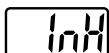
- Press and hold the **[SET]** button and release when **[F_2]** is displayed. 
- Press the **[SET]** button to display the lower three digits of integrated flow rate of **[1nL]** (**[1PL]** in the Non-Reverse Output mode) for OUT1.  When the Reverse Output mode is selected in initialization, **[1nL]** and the set value will be displayed alternately. (When the Non-Reverse Output mode is selected in initialization, **[1PL]** and the set value will be displayed alternately.)
- Press the **[Δ]** button or **[▽]** button to select a desired set value. Press the **[Δ]** button to increase the set value or the **[▽]** button to decrease the set value.
- Press the **[SET]** button to set the upper three digits of integrated flow rate value, and to move to the setting mode for **[1nH]** (**[1PH]** in the Non-Reverse Output mode).  When the Reverse Output mode is selected in initialization, **[1nH]** and the set value will be displayed alternately. (When the Non-Reverse Output mode is selected in initialization, **[1PH]** and the set value will be displayed alternately.)
- Press the **[Δ]** button or **[▽]** button to select a desired set value. Press the **[Δ]** button to increase the set value or the **[▽]** button to decrease the set value.
- Press the **[SET]** button to set the value and the display will return to measurement mode.

Output Selection (continue)

Integrated Switch Output

- Two output methods can be selected by selecting an output mode. One of these two output methods can be selected.

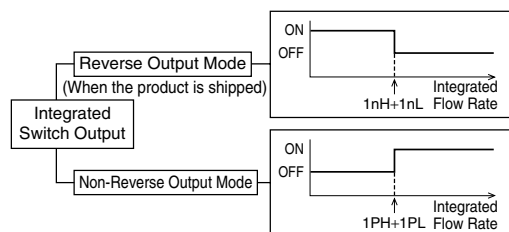

Integrated Pulse Output

- Pulse output for integrated flow rate measurement. Integrated pulse output in NPN or PNP open collector. (Same specification as that of switch output)

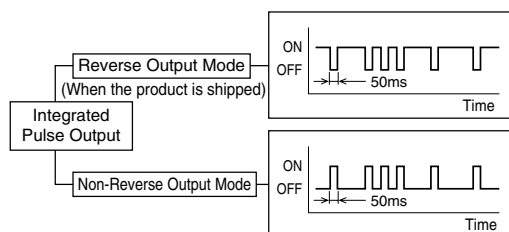

Output Selection

Instantaneous Switch Output Method

Four output methods can be selected by selecting an output mode and by combining large and small set values of OUT1. One of these four output methods can be selected.

- The minimum flow rate conversion set unit will be 1 digit. Refer to the specification for the minimum set unit.
- If hysteresis is reduced in hysteresis mode, switch output may start chattering when flow rate changes around set value.
- In window comparator mode, hysteresis is fixed at 3 digits. When used in window comparator mode, use 7 digits or more span between **[n_1]** and **[n_2]** or **[P_1]** and **[P_2]**.

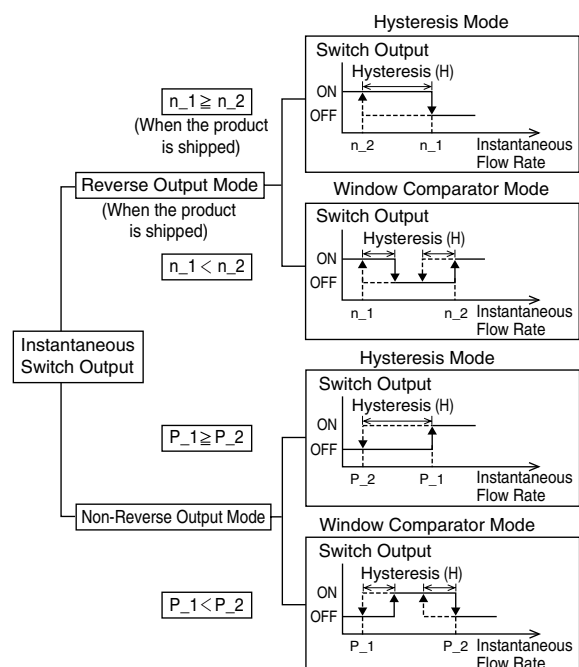

Special Setting

Copy function

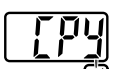
- Flow rate range, Display mode, Display unit (Only when [-M] is not assigned to unit specification in model indication), Output method, Output mode, Flow rate display unit (Only for PF2A20* for Air), Set value for a flow rate, can all be copied from channel to channel.
 - Press **[SET]** button, and release when **[F_1]** or **[F_2]** is displayed. Then press **[▽]** button to change the indication to **[F_3]**.
 - If output method is set to integrated pulse at initial setting, **[F_3]** is indicated by pressing **[SET]** button.
 - If copy mode setting is not required, **[SET]** button is pressed when **[F_3]** is indicated.
 - If **[Δ]** button is pressed when **[F_3]** is indicated, the display is changed to show **[CPY]** and the channel to be copied starts flashing. Select channel to be copied by pressing the **[Δ]** button. 
 - Press the **[SET]** button so that the display of the copied channel stops flashing.
 - [CPY]** and the channel to be pasted will display alternately. Next select the channel to be pasted by **[Δ]** button.

C_1 (CH1) ⇒ C_2 (CH2) ⇒ C_3 (CH3) ⇒ C_4 (CH4)

- Press the **[SET]** button to set the channels values, and return to **[F_3]** display.
- [Δ]** button is pressed again and the same operation is repeated to copy other channels.
- After copying is finished, **[SET]** button is pressed when **[F_3]** is indicated, to return to measurement mode.



Other Functions

Peak and Bottom Hold Display Function

When instantaneous flow rate indication mode is selected at initial setting, it is possible to hold max. or minimum value using the following operation.

- When instantaneous flow rate indication is shown, first **[▽]** button and then **[SET]** button are pressed and held simultaneously for 2 seconds or more. 
- Select Peak/Bottom mode by pressing **[Δ]** button.



n_P ⇔ **n_b** ⇔ **n_n**
(Peak mode) (Bottom mode) (w/o Peak/Bottom mode)

- Press **[SET]** button when **[n_P]** (Peak mode) is selected, the **[_]** shown lights up and peak value is indicated. 
- Press **[SET]** button when **[n_b]** (Bottom mode) is selected, the **[_]** shown lights up and bottom value is indicated. 
- Press **[SET]** button when **[n_n]** (w/o Peak/Bottom mode) is selected, the display is returned to measurement mode.
- To reset holding, select **[n_n]**.

Key Lock Function

This function prevents errors such as changing a set value by mistake. Set **[Loc]** (lock mode) in order not to accept button operation.

Lock

- Press and hold the **[SET]** button longer than 4 seconds. Release the button when **[unL]** is displayed. 
- Press the **[Δ]** button to set the display to **[Loc]**.
- Press the **[SET]** button to return to measurement mode. 
- * The channel select and channel scan operations are not locked in key lock **[Loc]** mode.

Unlock

- Press and hold the **[SET]** button longer than 4 seconds. Release the button when **[Loc]** is displayed.
- Press the **[Δ]** button to set the display to **[unL]**.
- Press the **[SET]** button to return to measurement mode.

Channel Select Function

- To select display of measurement value from channel to channel, press **[Δ]** button. Display will step through channels **[1→ 2→ 3→ 4→ 1→]**. Display shows flow value measured at the channel selected.

Channel Scan Function

- Press and hold **[Δ]** button for 2 seconds or more. The display indicates each channel measurement value for 2 seconds and then scans to the next channel.
- To reset this function, press **[Δ]** button again for 2 seconds or more.

Error Display Function

This function displays error location and nature when a problem or an error occurs.

Error name	Error display	Contents	Disposition
Over current error	Er 1	Over 80mA load current is flowing to output.	Turn the power off. Check the load and wiring of output to find cause of over current.
System error	Er 0	Internal data error causes this display.	Needs SMC investigation.
	Er 7	Internal date error causes this display.	
	Er 10	Internal data error causes this display.	Turn off the power, re-input power.
	Er 5	Internal date error causes this display.	
	Er 6	Internal date error causes this display.	

- If the above remedy does not recover the operation, the error needs to be investigated at SMC.

To enquire about the product, please contact the following.

SMC Corporation

URL <http://www.smcworld.com>

Phone	
AUSTRIA / (43) 2262-62 280	ITALY / (39) 02-92711
BELGIUM / (32) 3-355 1464	NETHERLANDS / (31) 20-531 8888
CZECH REP. / (420) 5-414 24611	NORWAY / (47) 67 12 90 20
DENMARK / (45) 70 25 29 00	POLAND / (48) 22-548 50 85
FINLAND / (358) 9-859 580	PORTUGAL / (351) 2 610 89 22
FRANCE / (33) 1-64 76 1000	SPAIN / (34) 945-18 4100
GERMANY / (49) 6103 4020	SWEDEN / (46) 8-603 0700
GREECE / (30) 1- 342 6076	SWITZERLAND / (41) 52-396 3131
HUNGARY / (36) 1-371 1343	TURKEY / (90) 212 221 1512
IRELAND / (353) 1-403 9000	UNITED KINGDOM / (44) 1908-56 3888