



Installation & Maintenance Manual

Electrostatic Sensor Monitor

Series IZE11□



1 Safety Instructions

- This manual contains essential information for the protection of users and others from possible injury and/or equipment damage.
- Read this manual before using the product, to ensure correct handling, and read the manuals of related apparatus before use.
- Keep this manual in a safe place for future reference.
- These instructions indicate the level of potential hazard by label of "DANGER", "WARNING" or "CAUTION", followed by important safety information which must be carefully followed.
- To ensure safety of personnel and equipment the safety instructions in this manual and the product catalogue must be observed, along with other relevant safety practices.

WARNING	If instructions are not followed there is a possibility of serious injury or loss of life.
CAUTION	If instructions are not followed there is a possibility of injury or equipment damage.

WARNING

- Do not disassemble, modify (including change of printed circuit board) or repair the product.**
An injury or product failure may result.
- Do not operate the product beyond the specification range.**
Fire, explosion or equipment damage may result. Use the product only after confirming the specifications.
- Do not use the product in the presence of flammable, explosive or corrosive gas.**
Fire, explosion or corrosion may result. This product does not have an explosion proof construction.
- When using the product as part of an interlocking system:**
 - Provide a double interlocking system, for example a mechanical system.
 - Check the product regularly to ensure proper operation.
- Before performing maintenance, be sure of the following:**
 - Turn off the power supply.
- Sensor to connect must be selected.**
Actual potential can not be displayed unless selected value of the connect sensor is correctly set.
At initial setting or when sensor connected, ensure the selected value of the connected sensor and the type of used electrostatic sensor are matched.

CAUTION

- Always perform a system check after maintenance.**
Do not use the product if any error occurs.
Safety cannot be assured if caused by un-intentional malfunction.
- Provide grounding to ensure correct operation and to improve noise resistance of the product.**
This product should be individually grounded using a short cable.
- Follow the instructions given below when handling the product. Failing to do so may result in product damage.**
 - Maintenance space should always be provided around the product.
 - Do not remove labels from the product.
 - Do not drop, hit or apply excessive shock to the product.
 - Follow all specified tightening torques.

1 Safety Instructions (continued)

- Do not bend, apply tensile force, or apply force by placing heavy loads, on the cables.
- Connect wires and cables correctly, and do not connect while the power is ON.
- Do not route wires and cables together with power or high-voltage cables.
- Check the insulation of wires and cables.
- Take proper measures against noise, such as noise filters, when the product is incorporated in equipment or devices.
- Select the required protection (IP) rating according to the environment of operation.
- Take sufficient shielding measures when the product is to be used in the following conditions:
 - where noise due to static electricity is generated.
 - where electro-magnetic field strength is high.
 - where radioactivity is present.
 - where power lines are located.
- Do not use the product in a place where electric surges are generated.
- Use suitable surge protection when a surge generating load such as a solenoid valve are to be directly driven.
- Prevent any foreign matter from entering this product.
- Do not expose the product to vibration or impact.
- Use the product within the specified ambient temperature range.
- Do not expose the product to any heat radiation.
- Do not clean the product with chemicals such as benzene or thinners.

Note

- Follow the instructions given below when operating the electrostatic sensor monitor. Otherwise, the electrostatic sensor monitor may be damaged or may fail, thereby resulting in malfunction.
- Do not pull the lead wire forcefully, or lift the product by pulling the lead wire.
 - Do not use in a place where oil or chemical splashes may occur.
 - Connect Terminal FG to the ground when using a switching regulator obtained on the commercial market.
 - Insert a noise filter (line noise filter, ferrite element or other element) between the switching regulator and monitor when analog output is used.
 - Do not press the buttons with a sharp pointed object.
 - To measure small electric potential, 20 to 30 min. of warm-up time is necessary. Initial drift of about $\pm 1\%$ F.S. occurs immediately after turning the power on.
 - Start measurement by the monitor 3s after turning the power on. Measurement output will be inaccurate for the first 3s.
 - The direct-current power supply to combine should use UL authorization power supply which is the class 2 power supply based on UL1310 or the power supply is using the transformer of a class 2 based on UL1585.
 - Electrostatic sensor or monitor will not withstand lightning surges. Protection against it must be provided for the device.
 - Do not turn off the power supply while setting functions to avoid storing of incorrect values or settings.

2 Specifications

Item	IZE11 ^w	
Connected sensor	Sensor for ± 0.4 kV	Sensor for ± 20 kV
Rated measured range	-0.4 kV to +0.4 kV <small>Note. 1)</small>	-20 kV to +20 kV <small>Note. 2)</small>
Set min. unit	0.001 kV	0.1 kV
Set measurement distance	10 to 50 mm	25 to 75 mm
Power supply voltage	24VDC $\pm 10\%$ or less (protection against reversed connection)	
Current consumption	50mA or less (Except current consumption at sensor)	
Sensor input	1 to 5VDC (Input impedance : 1M Ω)	
Input number	1 input	
	Input protection	
Protection against excess voltage (up to 26.4V)		
Hysteresis	Hysteresis mode : Variable Window comparator mode : Variable	
Switch output	NPN or PNP open collector output 2 outputs	
Max. load current	80 mA	
	Max. applied voltage	
30VDC (@ NPN output)		
Residual voltage	1V or less (@ 80mA load current)	
Short circuit protection	Short circuit protection included	
Response time (including sensor response time)	100ms or less When anti-chattering function is used, Response time is 500ms, 1s, 2s or less	
Voltage output	Output voltage : 1 to 5V (within rated measurement range) Output impedance : Approx. 1k Ω	
	Accuracy (to display value 25°C)	
$\pm 1\%$ F.S. or less		
Current output	Output current : 4 to 20mA (Rated measurement range) Max. load impedance : 600 Ω (@ 24VDC) Min. load impedance : 50 Ω	
	Accuracy (to display value 25°C)	
$\pm 1\%$ F.S. or less		

Item	IZE11 ^w	
Analogue output	Response time (including sensor response time)	200ms (No filter) 1.5s (with filter) or less
	Indicator Accuracy	$\pm 0.5\%$ F.S. ± 1 digit or less
Display method	3 1/2 digits 7 segment display, two color (red / green) indication, sampling cycle : 5 times / 1s	
Indicator lamp	OUT1 : Turns on when ON (green) OUT2 : Turns on when ON (red)	
Environmental resistance	Enclosure	IP40
	Operating temp. range	Operation : 0 to 50°C, Storage : -10 to 60°C (No condensation or freezing)
	Operating humidity range	Operation storage : 35 to 85% R.H. (No condensation)
	Withstand voltage	1000VAC 1 min. Between live parts and enclosure at monitor alone
	Insulation resistance	50M Ω or more (at 500VDC mega) Between live parts and enclosure at monitor alone
Vibration resistance	10 to 150Hz smaller one 1.5mm or 98m/s ² double amplitude each in directions of X, Y, and Z for 2 hours (De-energizing)	
	Impact resistance	100m/s ² 3 times each in directions of X, Y, and Z respectively (De-energizing)
Temp. characteristic	$\pm 0.5\%$ F.S. or less (25°C)	
Connection	Power and output lead wire : 5P connector Connector for sensor lead wire : 4P connector	
Material	Front case : PBT, Back case : PBT	
Weight	30g (Power supply and output cable not included)	
Standard	CE marking, UL (CSA) standards	

Note1) Rated value when the distance between charged object and the sensor is 25mm.

Note2) Rated value when the distance between charged object and the sensor is 50mm.

3 How to Order

IZE11□-□□□

Option 3	
Model	Contents
Nil	No option
C	Connector for sensor lead wire
Option 2	
Model	Contents
Nil	No option
A	Bracket
B	Panel mount adapter
D	Panel mount adapter + Front face protective cover
Option 1	
Model	Contents
Nil	No option
L	Power and output lead wire with cable

Output specification

Model	Contents
0	NPN open collector 2 outputs + Analogue output (1 to 5V)
1	NPN open collector 2 outputs + Analogue output (4 to 20mA)
2	PNP open collector 2 outputs + Analogue output (1 to 5V)
3	PNP open collector 2 outputs + Analogue output (4 to 20mA)

Option/Part number

Description	Part no.	Note
Power and output lead wire with cable (2m)	ZS-28-A	
Bracket	ZS-28-B	With M3 \times 5L (2pcs.)
Connector for sensor lead wire	ZS-28-C	1pc.
Panel mount adapter	ZS-27-C	With M3 \times 5L (2pcs.)
Panel mount adapter + Front face protective cover	ZS-27-D	With M3 \times 5L (2pcs.)

4 Mounting and Installation

Mounting

- Mount the optional bracket and panel mount adapter to the controller.

Mounting by bracket

- Fix the bracket to the controller with the set screws M3 \times 5L (2pcs.) as attached.
- The tightening torque of the set screws must be 0.5 to 0.7N·m.

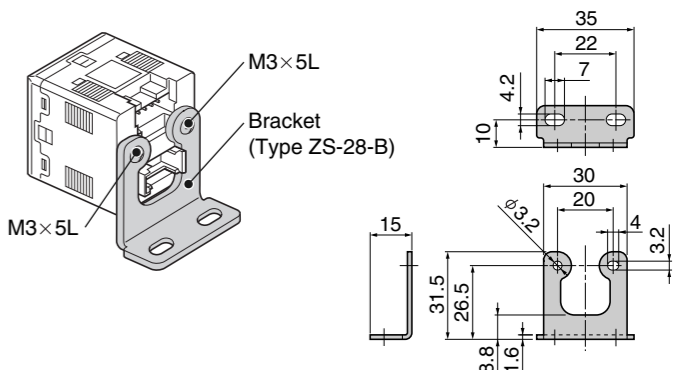

Mounting by Panel mount adapter

- Fix the panel mount adapter to the controller with the set screws M3 \times 8L (2pcs.) as attached.

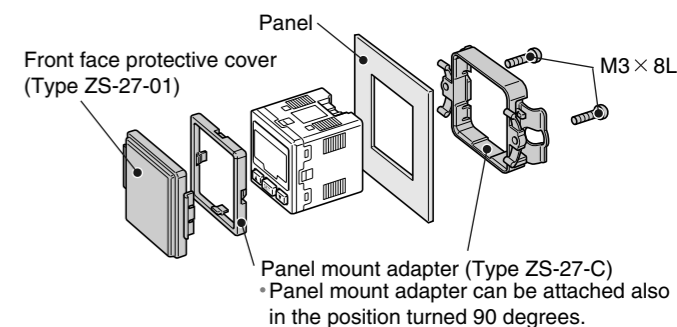

4 Mounting and Installation (continued)

Panel Hole Dimensions Separate

Panel Thickness : 0.5 to 6mm

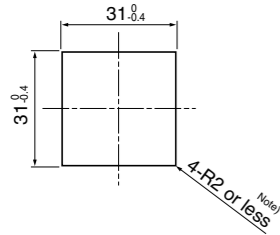

Note) When R is required, specify R2 or less.

Two or more in row

n : The number of controllers

Horizontal

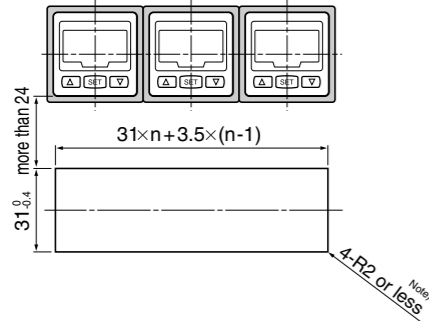

Vertical

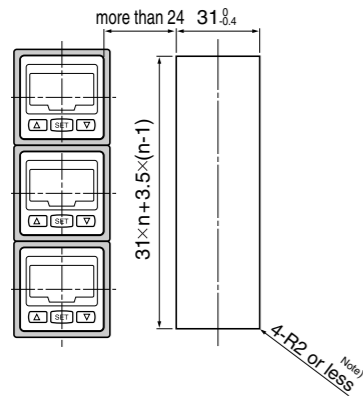

Notice when removing the controller

- The controller with adapter for panel mounting can be removed from facility by opening hooks of the controller as illustrated after removing two screws. Pressure sensor controller and Panel mount adapter may be damaged.

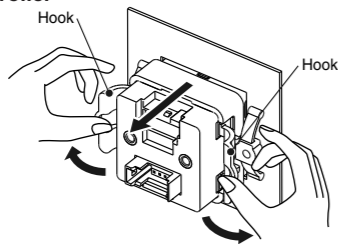

4 Mounting and Installation (continued)

Connection

- Make connection after turning the power off.
- Install the lead wire separately from the route for power cable or high-voltage cable. Otherwise, malfunction may potentially result due to noise.
- Be sure to ground Terminal FG when using a switching regulator obtained on the commercial market. If analogue output is performed connecting to a switching regulator obtained on the market, switching noise will be superimposed and product specification can no longer be met. This can be prevented by inserting a noise filter, such as a line noise filter and a ferrite element, between the switching regulator and the controller, or by using a series power supply instead of a switching regulator.

Attaching the connector to the lead wire

- Strip the sensor wire as shown in the figure. (Do not strip the cable wire sheath)
- The core of the corresponding color shown in the following table is put into the correct pin number printed on the connector and pushed to the back.

Pin No.	Wire Color
1	Brown (DC +)
2	NC
3	Blue (DC -)
4	White (IN : 1 to 5VDC)

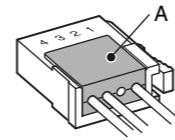
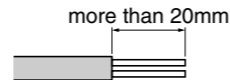

- Check that the above-mentioned preparation work has been performed correctly, and A part shown in the figure is pushed by hand and makes temporary connection.

- The centre part A is pushed straight in using a suitable tool, such as pliers.
- Re-use cannot be performed once the connector has been closed completely. When connection failure occurs such as incorrect fitting of wires, or incomplete insertion, please use a new connector.
- When the sensor cable is a short length, do not connect the shield wire. (The shield wire is common with amplifier case. Frame ground should be prepared at the amplifier case side.)

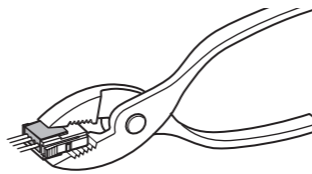

5 Outline dimensions (mm)

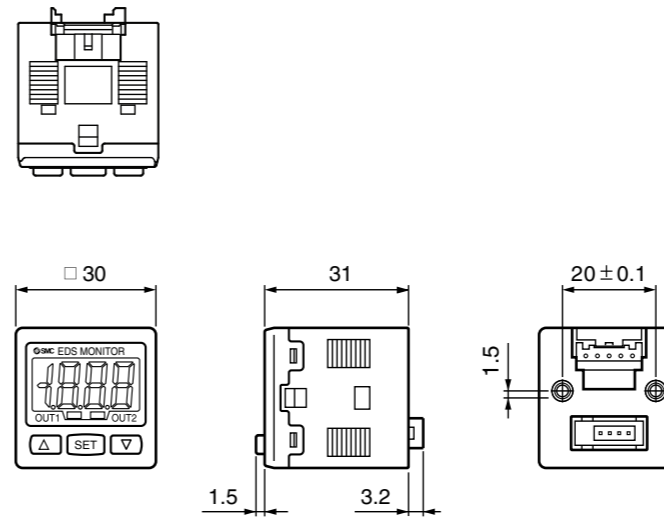

6 Names / Functions of individual Parts

Output (OUT1) display (Green) : Lit when OUT1 is ON.
Output (OUT2) display (Red) : Lit when OUT2 is ON.

LCD display : Displays the current status of charged potential, set mode condition and error code. Four display modes can be selected display always in red or green only, or changing from green to red linked to output.

- ▲** button : Selects a mode and increases a set ON/OFF value. Press this button to change to the peak display mode.
- ▼** button : Selects a mode and decreases a set ON/OFF value. Press this button to change to the bottom display mode.
- SET** button : Changes the mode and sets a set value.

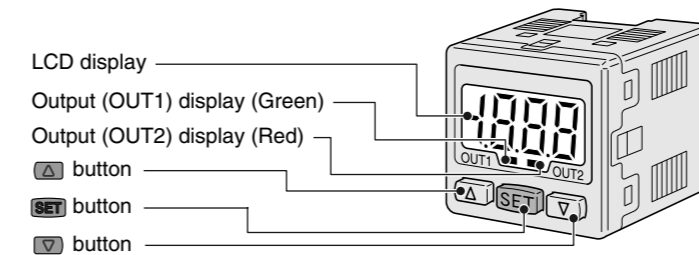

6 Names / Functions of individual Parts (continued)

Options

Power and output lead wire with cable (2m) : ZS-28-A
Connector for sensor lead wire (1pc.) : ZS-28-C

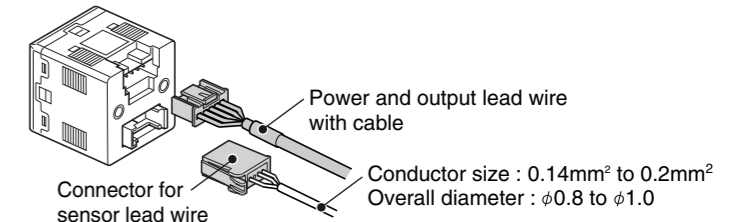

Bracket with set screws M3×5L (2pcs.) : ZS-28-B

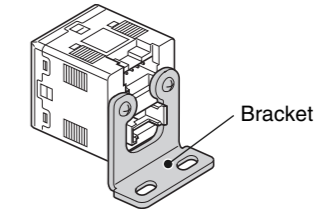

Panel mount adapter with set screws M3×8L (2pcs.) : ZS-27-C
Panel mount adapter with set screws M3×8L (2pcs.)

+ Front face protective cover : ZS-27-D

Front face protective cover : ZS-27-01

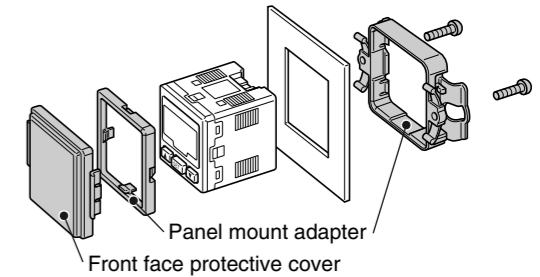

7 Internal Circuit and Wiring

Connector Connecting/Disconnecting

- When connecting the connector, insert it straight onto the pin holding the lever and connector body and lock the connector by pushing the lever claw into the square groove in the housing until connector clicks.
- When disconnecting the connector, push down the lever to disengage the lever claw from the square groove. Then pull the connector straight out.

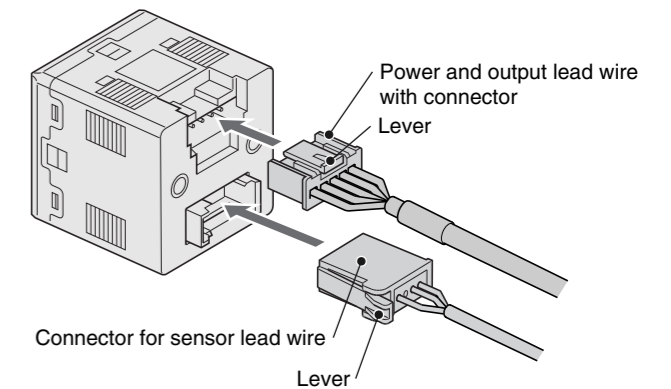

Power and Output Connector Pin numbers

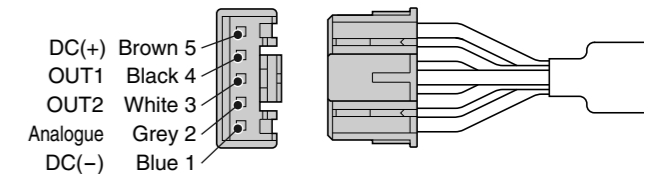

7 Internal Circuit and Wiring (continued)

Output Specification

When the SMC power and output lead wire (type ZS-28-A) is used, the colors of wire (Brown, Black, White, Grey, Blue) will apply as shown on the circuit diagram.

IZE110

NPN Open Collector Output :

2 Outputs

Max. 30V, 80mA

Residual voltage 1V or less

Analogue Output : 1 to 5V

Output Impedance :

Approx. 1k Ω

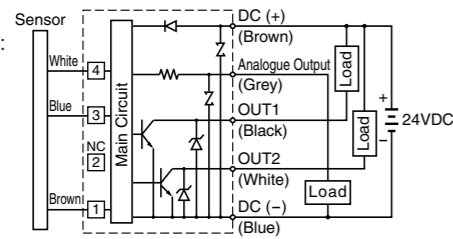

IZE111

NPN Open Collector Output :

2 Outputs

Max. 30V, 80mA

Residual voltage 1V or less

Analogue Output : 4 to 20mA

Max. Load Impedance:

600 Ω (@ 24VDC)

Min. Load Impedance: 50 Ω

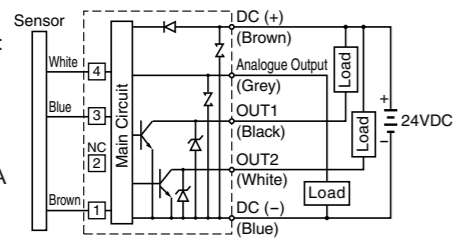

IZE112

PNP Open Collector Output :

2 Outputs

Max. 80mA

Residual voltage 1V or less

Analogue Output : 1 to 5V

Output Impedance :

Approx. 1k Ω

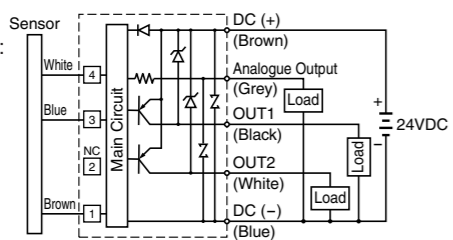

IZE113

PNP Open Collector Output :

2 Outputs

Max. 80mA

Residual voltage 1V or less

Analogue Output : 4 to 20mA

Max. Load Impedance :

600 Ω (@ 24VDC)

Min. Load Impedance :

50 Ω

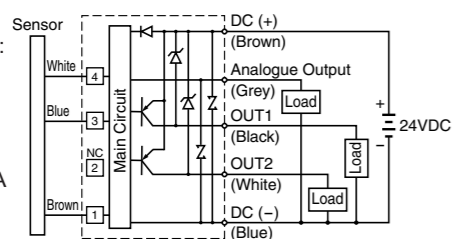

8 Contacts

AUSTRIA	(43) 2262 62280	NETHERLANDS	(31) 20 531 8888
BELGIUM	(32) 3 355 1464	NORWAY	(47) 67 12 90 20
CZECH REP.	(420) 541 424 611	POLAND	(48) 22 211 9600
DENMARK	(45) 7025 2900	PORTUGAL	(351) 21 471 1880
FINLAND	(358) 207 513513	SLOVAKIA	(421) 2 444 56725
FRANCE	(33) 1 6476 1000	SLOVENIA	(386) 73 885 412
GERMANY	(49) 6103 4020	SPAIN	(34) 945 184 100
GREECE	(30) 210 271 7265	SWEDEN	(46) 8 603 1200
HUNGARY	(36) 23 511 390	SWITZERLAND	(41) 52 396 3131
IRELAND	(353) 1 403 9000	UNITED KINGDOM	(44) 1908 563888
ITALY	(39) 02 92711		

SMC Corporation

URL <http://www.smcworld.com> (Global) <http://www.smceu.com> (Europe)

Specifications are subject to change without prior notice from the manufacturer.
© SMC Corporation All Rights Reserved.