

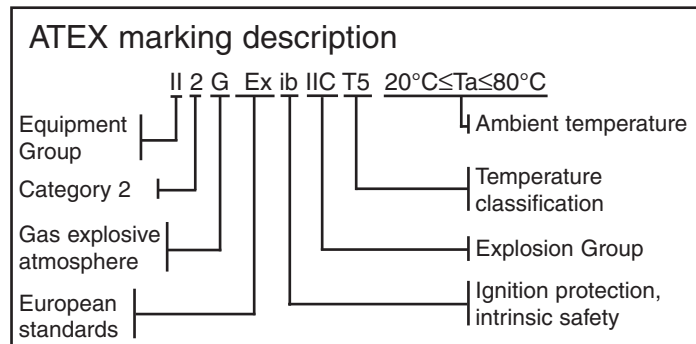

**Installation and Maintenance Manual**  
**IP8000/IP8100 0#0 - # - X14**  
**Electropneumatic Positioner**

II 2G Ex ib IIC T6 -20°C ≤ Ta ≤ 60°C  
 T5 -20°C ≤ Ta ≤ 80°C



**1 Safety Instructions**

- This manual contains essential information for the protection of users and others from possible injury and/or equipment damage.
- Read this manual before using the product, to ensure correct handling, and read the manuals of related apparatus before use.
- Keep this manual in a safe place for future reference.
- These instructions indicate the level of potential hazard by label of "DANGER", "WARNING" or "CAUTION", followed by important safety information which must be carefully followed.

- To ensure safety of personnel and equipment the safety instructions in this manual and the product catalogue must be observed, along with other relevant safety practices.

|                  |  |
|------------------|--|
| <b>⚠ DANGER</b>  | In extreme conditions, there is a possibility of serious injury or loss of life.           |
| <b>⚠ WARNING</b> | If instructions are not followed there is a possibility of serious injury or loss of life. |
| <b>⚠ CAUTION</b> | If instructions are not followed there is a possibility of injury or equipment damage.     |

**⚠ WARNING**

- The compatibility of pneumatic equipment is the responsibility of the person who designs the pneumatic system or decides its specifications.**  
 Since the products specified here can be used in various operating conditions, their compatibility with the specific pneumatic system must be based on specifications or after analysis and/or tests to meet specific requirements.
- Only trained personnel should operate pneumatically operated machinery and equipment.**  
 Compressed air can be dangerous if an operator is unfamiliar with it. Assembly, handling or repair of pneumatic systems should be performed by trained and experienced personnel.
- Do not service machinery/equipment or attempt to remove components until safety is confirmed.**  
 1) Inspection and maintenance of machinery/equipment should only be performed after confirmation of safe locked-out control positions.  
 2) When equipment is to be removed, confirm the safety process as mentioned above. Switch off air and electrical supplies and exhaust all residual compressed air in the system.  
 3) Before machinery/equipment is re-started, ensure all safety measures to prevent sudden movement of cylinders etc. (Supply air into the system gradually to create back pressure, i.e. incorporate a soft-start valve).

**1 Safety Instructions (continued)**

- Do not use this product outside of the specifications. Contact SMC if it is to be used in any of the following conditions:**
  - Conditions and environments beyond the given specifications, or if the product is to be used outdoors.
  - Installations in conjunction with atomic energy, railway, air navigation, vehicles, medical equipment, food and beverage, recreation equipment, emergency stop circuits, press applications, or safety equipment.
  - An application which has the possibility of having negative effects on people, property, or animals, requiring special safety analysis.

**⚠ CAUTION**

- Ensure that the air supply system is filtered to 5 microns.

**2 Specifications**

Protect the unit from impact and dropping during Installation and when mounted. It may cause failure of the unit.

- Do not use the unit in places with high humidity & temperature. It may cause malfunctions.
- Do not use this positioner outside of the range of it's specifications as this can cause failure.

| Item                                   | Type | IP8000   |                 | IP8100         |               |
|--|------|--|-----------------|----------------|---------------|
|  |      | Lever type lever   | Rotary type cam | Single action  | Double action |
| Input current                          |      | 4~20mADC (Standard)*1  |                 |                |               |
| Input resistance                       |      | 235 ± 15Ω (4~20mADC)   |                 |                |               |
| Supply air pressure                    |      | 0.14~0.7Mpa  |                 |                |               |
| Standard stroke                        |      | 10 ~ 85mm (External lever allowable runout angle 10° ~ 30°)  |                 | 60° ~ 100°*2   |               |
| Sensitivity                            |      | Within 0.1%F S   |                 | Within 0.5%F S |               |
| Linearity                              |      | Within ±1%F S  |                 | Within ± 2%F S |               |
| Hysteresis                             |      | Within 0.75%F S  |                 | Within 1%F S   |               |
| Repeatability                          |      | Within ± 0.5%F S   |                 |                |               |
| Thermal coefficient                    |      | Within 0.1%F S/°C  |                 |                |               |
| Output flow rate                       |      | 80 l/min (ANR) or more (SUP=0.14MPa)*3   |                 |                |               |
| Air consumption                        |      | Within 5 l/min (ANR) (Sup=0.14MPa)   |                 |                |               |
| Ambient and using fluid temperature    |      | -20°C ~80°C (T5)<br>-20°C ~60°C (T6)   |                 |                |               |
| Explosion protected Construction       |      | Intrinsic safety type of explosion protection<br>CE 0344 Ex ib IIC T5/T6<br>Approval No. KEMA No.03 ATEX1119 |                 |                |               |
| Air connection port                    |      | 1/4NPT female screw  |                 |                |               |
| Electric wiring connection port        |      | M20 x 1.5  |                 |                |               |
| Material                               |      | Aluminum diecast for the body  |                 |                |               |
| Mass                                   |      | Approx. 2.4kg  |                 |                |               |
| Classification of degree of protection |      | JISF8007 IP65 (IEC 60529)  |                 |                |               |
| Parameters (Current circuit)           |      | Ui ≤ 28V, Ii ≤ 125mA, Pi ≤ 1.2W, Ci ≤ 0nF, Li ≤ 0mH  |                 |                |               |

\*1 : 1/2 split range is possible with the standard type (by adjusting the span)  
 \*2 : The stroke is adjustable in 0~60° and 0~100°.  
 \*3 : Standard air (JIS B0120): temp.20°C, absolute press. 760mmHg, ratio humidity 65%.

**2 Specifications (continued)**

**2.1 How to Order**

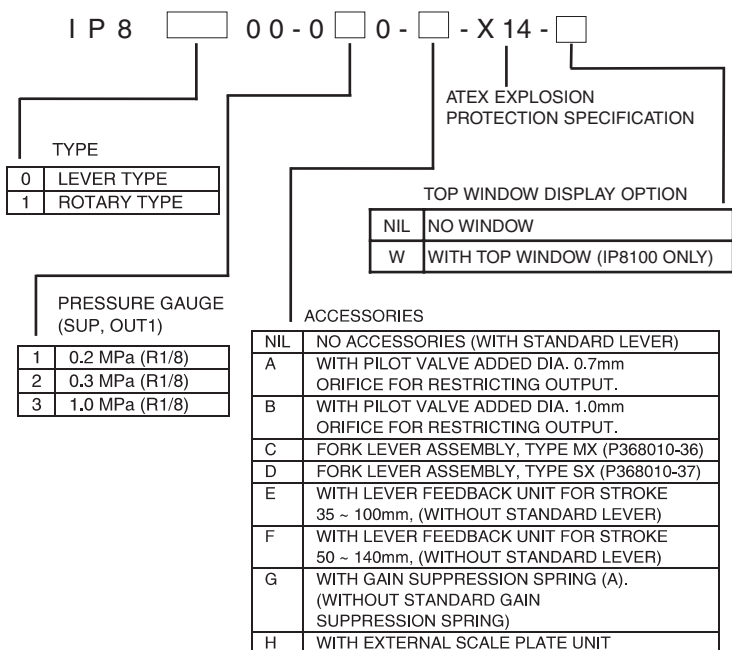

NOTE : WHEN MORE THAN 2 ACCESSORIES ARE REQUIRED, THE SYMBOL SHOULD BE STATED IN ALPHABETICAL ORDER.

**3 Installation**

**⚠ WARNING**

- Do not install unless the safety instructions have been read and understood.
- Since zero-point varies depending on the mounting position, the zero point should be adjusted after installation.
- Avoid hitting the product with metallic objects!
- Avoid using this product in non-explosive environments which can become explosive due to air leakage!
- When using this product in hazardous areas, ensure that the operational speed of the moving parts is less than 1m/s, and that the actuator is not hunting!

**3.1 Environment**

**⚠ WARNING**

- Do not use in an environment where the product is directly exposed to corrosive gases, chemicals, salt water, water or steam.
- The product should not be exposed to prolonged sunlight that can generate a surface temperature higher than the value given for the temperature classification. Use a protective cover.
- Do not mount the product in a location where it will be subject to strong vibrations and/or shock.
- Do not mount the product in a location where it is exposed to radiant heat.
- Allow sufficient space for maintenance and adjustment around the product when mounted.

**3.2 Piping**

**⚠ CAUTION**

- Before piping make sure to clean away all chips, cutting oil, dust etc.
- When installing piping or fitting into a port, ensure that sealant material does not enter the port inside. When using seal tape, leave 1.5 to 2 threads exposed on the end of the pipe/fitting.

**3 Installation (continued)**

**3.3 Lubrication**

**⚠ CAUTION**

- The positioner has a fixed orifice and nozzle, which contain fine paths in them. Use filtered, dehydrated air and avoid the use of lubricators as this may cause malfunction of the positioner. Ensure that the air supply system is filtered to 5 micron.

**3.4 Handling**

**⚠ CAUTION**

- Avoid giving impact to the body and torque motor of the positioner, and giving excessive force to the armature because this leads to failure. Handle with care during transport and operation.
- If you leave the positioner at the operation site for a long time without using it, put the cover on it so that rain water does not enter the positioner. If the atmosphere is of high temperature or humidity, take measures to avoid condensation inside. The condensation control measures must be taken thoroughly for export shipment.
- Avoid setting the positioner near magnetic fields because the characteristics are effected.

**4 Mounting**

**4.1 Type IP8000**

**4.1.1 Example of attaching to actuator**

The type IP8000 positioner is compatible with Type IP6000 and IP600 in the attaching pitch. If you are using IP600 and IP6000 already, the bracket for these positioner can be used to attach IP8000 to the actuator.

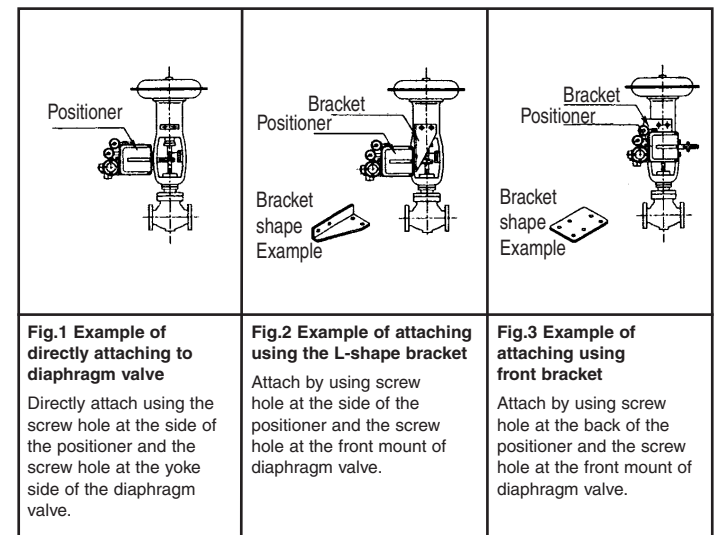

**Fig.1 Example of directly attaching to diaphragm valve**  
 Directly attach using the screw hole at the side of the positioner and the screw hole at the yoke side of the diaphragm valve.

**Fig.2 Example of attaching using the L-shape bracket**  
 Attach by using screw hole at the side of the positioner and the screw hole at the front mount of diaphragm valve.

**Fig.3 Example of attaching using front bracket**  
 Attach by using screw hole at the back of the positioner and the screw hole at the front mount of diaphragm valve.

## 4 Mounting (continued)

### 4.1.2 Connection with external feedback lever

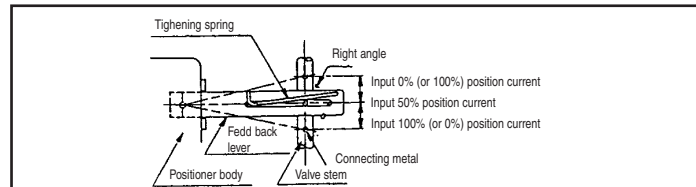

Fig.4 Attaching the feed back lever

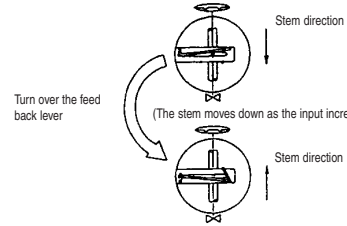

Fig.5 Use position for feedback lever

- Attach to the position that the valve stem and lever form the right angle when the input signal is 50% (distribute evenly with 50% input signal set as the reference).
- Attach to the position of the runout angle is within the range of 10° to 30°.
- To move the valve stem downward at the time of input current increase (normal actuation), attach to the position at which the tightening spring comes to the upper side of the connecting metal, as shown in Fig. 5. To move the valve stem upward (reverse actuation), turn-over the feedback lever and attach to the position at which the tightening spring comes to the lower side of connecting metal.

### 4.2 Type IP8100

#### 4.2.1 Example of attaching to actuator

The type IP8000 positioner is compatible with type IP610 and IP6100 in the attaching pitch. If you are using IP610 or IP6100 already, the bracket can be used to attach IP8000 to the actuator. If you change from IP6100 to IP8100 and select accessory H (with external scale plate), fork lever type fitting needs to be adjusted at lower position.

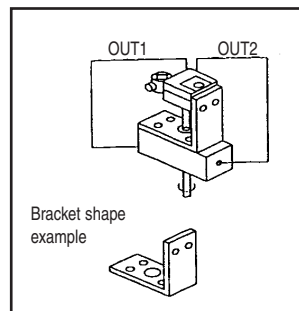

Fig.6 Example of attaching using the positioner side screw

Attaching using the screw hole of a side of the positioner and the screw hole at the actuator top.

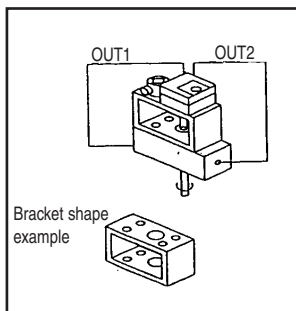

Fig.7 Example of attaching using the positioner back screw

Attaching using the screw hole at the positioner back and the screw hole at the actuator top.

### 4.2.2 Connection with feedback shaft

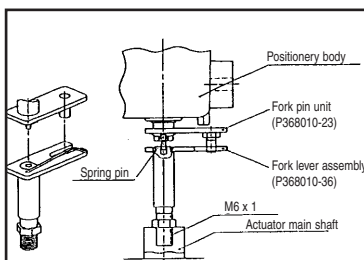

Fig.8 Attaching the feed back lever

- Attach to the position at which the positioner feed back shaft and the rotary actuator main shaft are almost concentric (range in which the spring pin of feed back shaft edge enters the hole of fork lever assembly shaft edge).
- If the seration joint type for IP610 is made in a special specification, it can be used for this connection.

## 4 Mounting (continued)

### 4.2.3 Cam attaching procedure

#### CAUTION

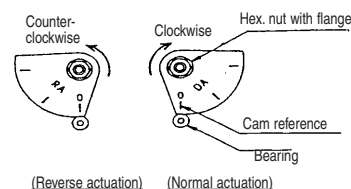

Fig.9 Example of cam attaching

- Use the DA face of the cam to turn the actuator main shaft clockwise (viewed from the positioner front cover side) at the time of input signal increase. Use the RA face to turn it counter-clockwise (reverse actuation). Correctly attach the cam to the flange part of feed back shaft.
- Attach the cam in the procedure of loosening the hexagonal nut with flange first, setting the using actuorto the starting position and then setting the cam reference line and the bearing contact point of span adjusting arm unit to the matching position.
- Do not apply the supply pressure when attaching the cam as otherwise it is very dangerous.
- When the positioner is shipped out of our plant, the cam is tentatively tightened to the shaft. Be sure to firmly lock the cam to the lock nut [tightening torque 2.0 ~ 2.5 Nm.

## 5 Adjustment (continued)

- Check for correct use of the cam face (normal or reverse) in Type IP8100 and that the flange nut is firmly locked. (Refer to Table 2.)
- Check that the wires are connected correctly with the (+), (-) and grounding terminals.

|                       | Type IP8000  | Type IP8100  |
|-----------------------|--|--|
| Zero point adjustment | <p>Zero adjusting knob<br/>Span adjusting screw<br/>Move clockwise to span adjustment<br/>Move counter-clockwise to span adjustment<br/>Spanning point OK</p>  | <p>When the zero adjusting knob is turned clockwise, the starting point increases. When it is turned counter-clockwise, the starting point decreases.<br/>Decrease of starting points<br/>Increase of starting points<br/>Counter-clockwise turn<br/>Stroke<br/>Input current</p>  |
| Span adjustment       | <p>Span adjusting screw<br/>Lock screw<br/>*1<br/>Too small span<br/>Span OK<br/>Move clockwise<br/>Too large span<br/>Move counter-clockwise</p>  | <p>Span adjusting screw<br/>*2<br/>Too small span<br/>Span OK<br/>Move counter-clockwise<br/>Too large span<br/>Move clockwise</p>   |
| Adjusting procedure   | <ol style="list-style-type: none"> <li>Set the input current to 0% (4mA DC in the standard specification) and turn the zero adjusting knob by hand to set it to the actuator starting point.</li> <li>Then set the input current to 100% (20mA DC in the standard specification) and check the actuator stroke. At this point depending on the span is too large or too small, loosen the lock screw and adjust the span as shown in the illustration above.</li> <li>Set the input current to 0% and conduct the zero point adjustment, as done in Step (1) again.</li> <li>Repeat the above operations until the predetermined stroke of the actuator is obtained to the input current.</li> </ol> | <ol style="list-style-type: none"> <li>Set the input current to 0% (4mA DC in the standard specification) and turn the zero adjusting knob by hand to set it to the actuator starting point.</li> <li>Then set the input current to 100% (20mA DC in the standard specification) and check the actuator stroke. At this point depending on the span is too large or too small, loosen the lock screw and adjust the span as shown in the illustration above.</li> <li>Set the input current to 0% and conduct the zero point adjustment, as done in Step (1) again.</li> <li>Repeat the above operations until the predetermined stroke of the actuator is obtained to the input current.</li> </ol> |

## 5 Adjustment (continued)

#### WARNING

To use as explosion protection specification may only be connected to a certified intrinsically safe electrical circuit with the following maximum values.

Parameters (current circuit)  
 $U_i \leq 28V$ ,  $I_i \leq 125mA$ ,  $P_i \leq 1.2W$ ,  $C_i \leq 0nF$ ,  $L_i \leq 0mH$

## 6 Maintenance

#### WARNING

- After installation, repair and disassembly, connect compressed air and perform a proper function test and leak test. If bleed noise is louder than the initial state, or operation is abnormal, stop operation and check if installation is correct or not.
- Modification of Electrical construction is prohibited to maintain explosion proof certification.

#### CAUTION

- Check if supply air is clean or not. Inspect compressed air cleaning system periodically so that dust, oil and humidity, which can cause malfunction and failure of the unit, do not enter the equipment
- If handled improperly, compressed air can be dangerous. Maintenance and replacement of unit parts should only be performed by trained and experienced personnel for instrumentation equipment, as well as following the product specifications.
- Check the positioner once a year. When an excessively worn diaphragm, O-ring or other packing of any unit that has been damaged is found, replace with new ones. Treatment at an early stage is especially important if the positioner is used in a place of severe environment, such as coastal areas.
- Before removing the positioner for maintenance, or replacing unit parts after installation, ensure the supply pressure is shut off and all residual air pressure is released from the piping.

Table 2

|                   | IP8000 (Lever type)  | IP8100 (Rotary type)   |
|-------------------|--|--|
|                   | Single action  | Double action  |
| Normal actuation  | <p>Actuation: The stem moves in the arrow direction when the input current increases.</p> <p>OUT 1<br/>OUT 2: Plug<br/>Span adjusting lever normal position</p>  | <p>Actuation: The actuator main shaft turns clockwise when the input signal increases.</p> <p>Main shaft<br/>OUT 1<br/>OUT 2<br/>Double action actuator<br/>The cam should be set to DA surface.</p>         |
| Reverse actuation | <p>Actuation: The stem moves in the arrow direction when the input current increases. (Reverse actuation using the normal actuation drive unit).</p> <p>OUT 2<br/>OUT 1: Plug<br/>Span adjusting lever normal position</p> | <p>Actuation: The actuator main shaft turns counter-clockwise when the input signal increases.</p> <p>Main shaft<br/>OUT 2<br/>OUT 1<br/>Double action actuator<br/>The cam should be set to RA surface.</p> |

## 5 Adjustment

#### CAUTION

Check the following prior to start the adjustment.

- Check that the pipeline is correctly connected with the pressure supply port and OUT1 and OUT2 ports.
- Check that the actuator and positioner are sturdily connected.
- Check that the span adjusting lever of internal feed back (Type IP8000) is attached to the correct (normal or reverse) position. (Refer to Tables 2.)
- Check for locking of the auto/manual changeover screw of pilot valve (fully tightened in the clockwise direction).

\*1 When the span adjusting screw is turned clock-wise with a slothead(-) screwdriver, the span increases. When it is turned counter-clockwise, the span decreases.

\*2 When the span adjusting screw is turned clock-wise with a slothead(-) screwdriver, the span decreases. When it is turned counter-clockwise, the span increases.

#### CAUTION

- For this positioner, span and zero point adjustment of each actuator is necessary. Adjustment shall be done based on each actuator size.
- Keep in mind that span and zero point adjustment interfere in each other.
- Characteristics changes due to change of mounting position, ambient temperature and supply pressure.
- If it takes long time until the operation after initial adjustment, check and adjust this product.
- Sensitive adjustment is effective for only double acting actuator.
- Manual change function is effective for single acting actuator which is controlled by using OUT1.

### 5.1 Electrical wiring

Connect the (+) and (-) output terminal of positioner with the (+) and (-) input terminal of positioner respectively. The input port of the electrical connection is equipped with a (blue) cable connector M20 x 1.5.

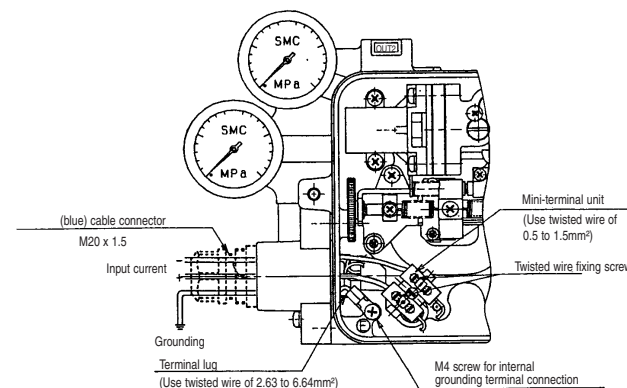

## 7 Contact

|            |                   |                |                   |
|------------|-------------------|----------------|-------------------|
| AUSTRIA    | (43) 2262 62280   | NETHERLANDS    | (31) 20 531 8888  |
| BELGIUM    | (32) 3 355 1464   | NORWAY         | (47) 67 12 90 20  |
| CZECH REP. | (420) 541 424 611 | POLAND         | (48) 22 211 9600  |
| DENMARK    | (45) 7025 2900    | PORTUGAL       | (351) 21 471 1880 |
| FINLAND    | (358) 207 513513  | SLOVAKIA       | (421) 2 444 56725 |
| FRANCE     | (33) 1 6476 1000  | SLOVENIA       | (386) 73 885 412  |
| GERMANY    | (49) 6103 4020    | SPAIN          | (34) 945 184 100  |
| GREECE     | (30) 210 271 7265 | SWEDEN         | (46) 8 603 1200   |
| HUNGARY    | (36) 23 511 390   | SWITZERLAND    | (41) 52 396 3131  |
| IRELAND    | (353) 1 403 9000  | UNITED KINGDOM | (44) 1908 563888  |
| ITALY      | (39) 02 92711     |                |                   |

# SMC Corporation

URL <http://www.smcworld.com> (Global) <http://www.smceu.com> (Europe)

Specifications are subject to change without prior notice from the manufacturer. The descriptions of products in this document may be used by other companies.

© SMC Corporation All Rights Reserved.